

SECTIONAL VIEW - PROLIFT SCL Model 3548 TYPE 1R

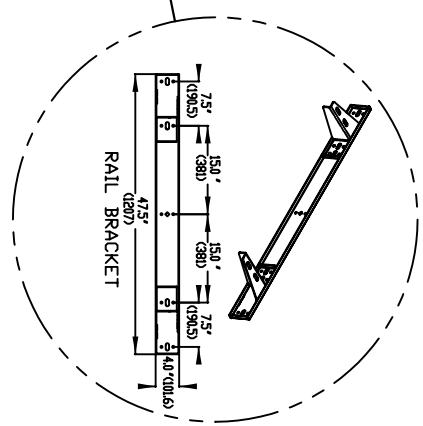
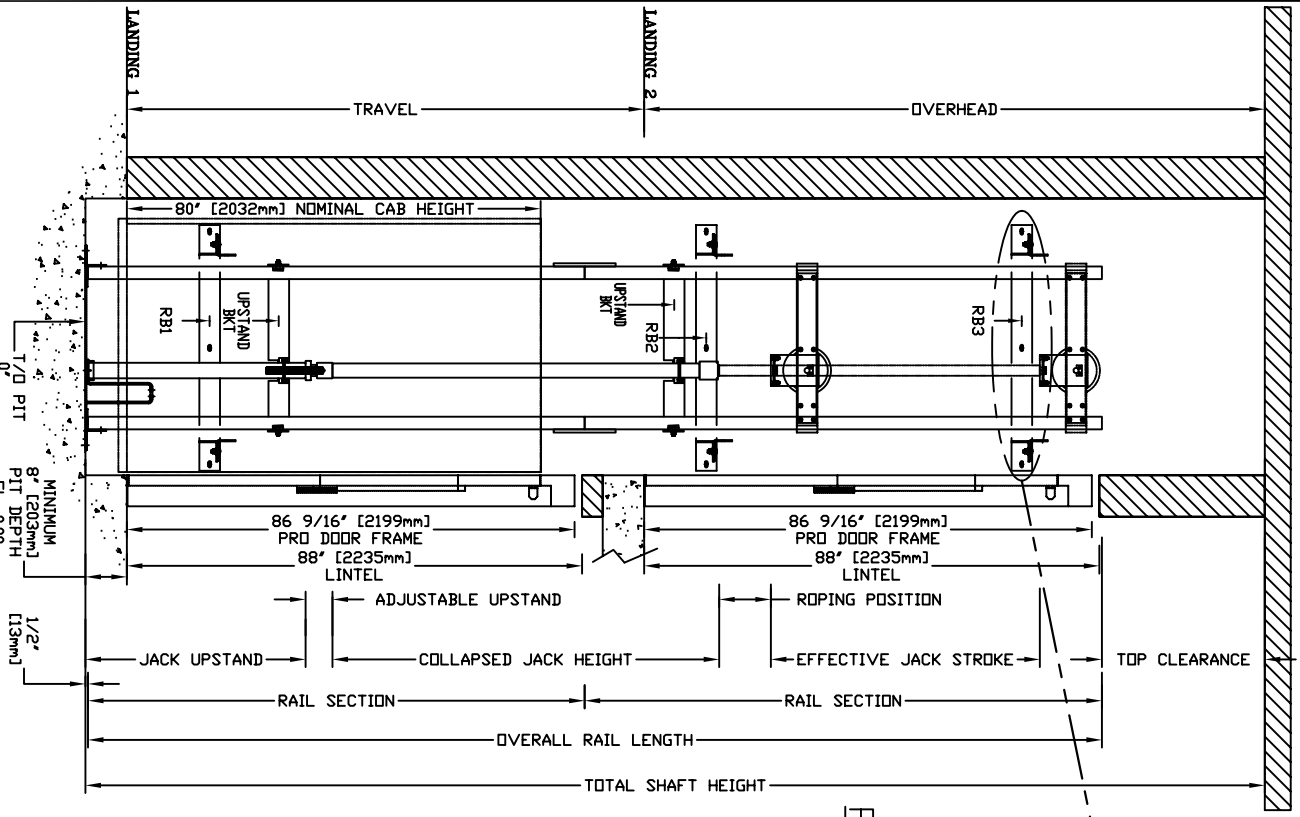

RAIL FORCES	
*R1	*R2
3041bf.	1941bf.
RAIL WEIGHT = 80 lbs / ft	

R3 NOTE:
PIT FLOOR TO SUPPORT LOAD OF:
56kips * (INCLUDES IMPACT)
R1 MUST BE DOUBLED @ 6092LB.

PLAN VIEW - PROLIFT SCL Model 3548 TYPE 1R

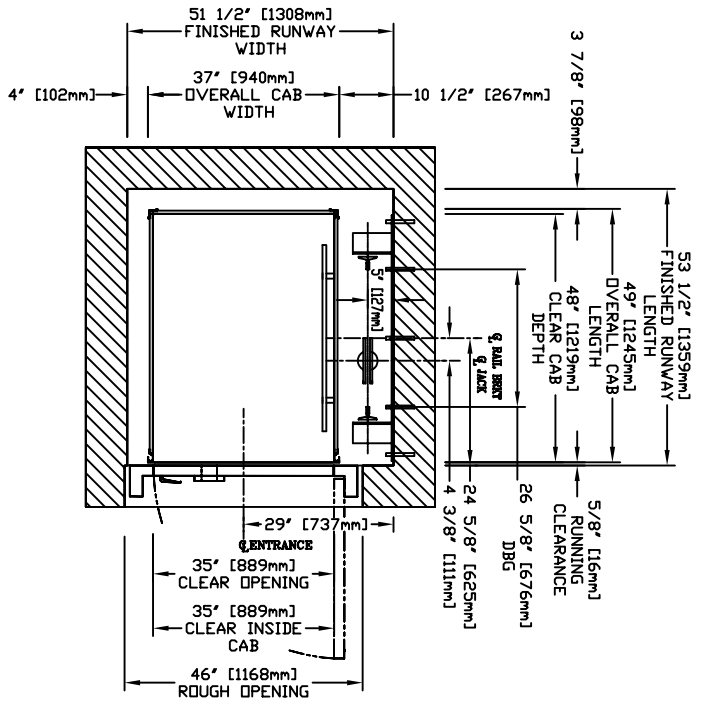

RAIL BRACKET

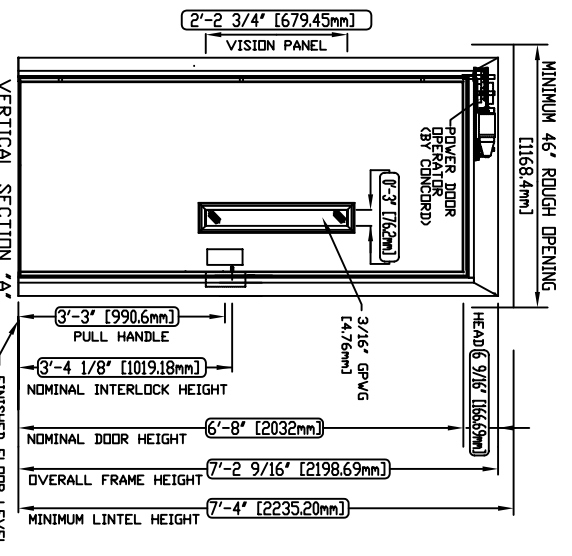

VERTICAL SECTION 'A-A'
FLUSH PRO-AUTO DOOR

TOP RAIL BRACKET	AT TOP OF HOISTWAY CONCORD REPRESENTATIVE FOR EXACT LOCATION	FLOOR No. REAR FRONT	FLOOR HEIGHT
RB3			
INTERMEDIATE RAIL BRACKET	96" [2438mm] ABOVE BOTTOM BRACKET		
RB2			
BOTTOM RAIL BRACKET	24" [610mm] ABOVE PIT FLOOR		
RB1			
TOTAL RISE			

PIT / OVERHEAD REQUIREMENTS			
MAX. SPEED (ft/min)	MIN. PIT	TOTAL TRAVEL	MINIMUM OVERHEAD
30	8" ***	92" (2337)	

*** NOTE: Additional pit equipment required when over 36" [914.4mm] deep, consult your local dealer for details

DOCUMENT REVISION #0, DATE: 03/02/05

COMMERCIAL WHEELCHAIR LIFT
PROLIFT SCL MODEL 3548 TYPE 1R

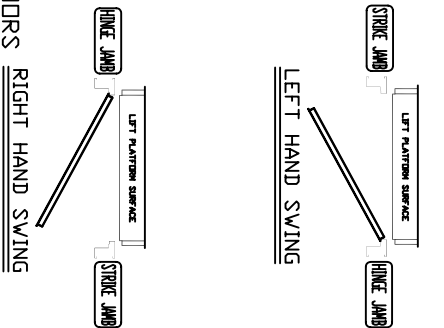
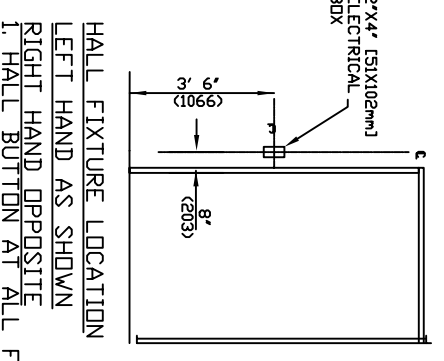
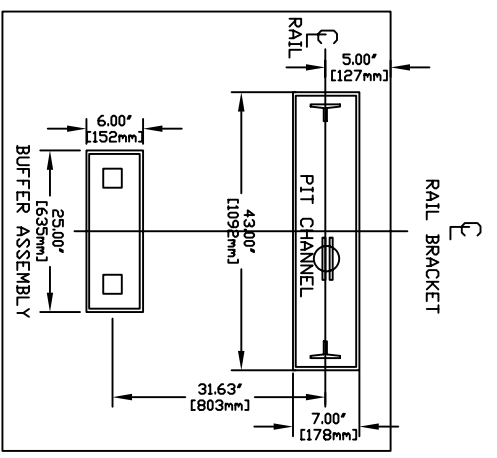

PROVISIONS BY OTHERS

GENERAL- HOISTWAY- THE HOISTWAY MUST BE IN ACCORDANCE WITH B355 /SAFETY CODE FOR ELEVATORS AND ESCALATORS (ASME A18.1) AND ALL STATE/PROVINCIAL AND LOCAL CODES.
PLUMB HOISTWAY- DUE TO CLOSE RUNNING CLEARANCES OWNER/AGENT MUST ENSURE THAT HOISTWAY AND PIT (WHERE PROVIDED) ARE LEVEL, PLUMB AND SQUARE AND ARE IN ACCORDANCE WITH THE DIMENSIONS ON THESE DRAWINGS.
MINIMUM OVERHEAD CLEARANCE- OWNER/AGENT MUST ENSURE MINIMUM OVERHEAD CLEARANCE IS IN COMPLIANCE WITH CODES.
CONSTRUCTION SITE- OWNER/AGENT TO PROVIDE ALL MASONRY, CARPENTRY AND DRYWALL WORK AS REQUIRED AND SHALL PATCH AND MAKE GOOD (INCLUDING FINISH PAINTING) ALL AREAS WHERE WALLS/FLOORS MAY REQUIRE TO BE CUT, DRILLED OR ALTERED IN ANY WAY TO PERMIT THE PROPER INSTALLATION OF THE LIFT.
DIMENSIONS- CONTRACTOR/CUSTOMER TO VERIFY ALL DIMENSIONS AND REPORT ANY DISCREPANCIES TO OUR OFFICE IMMEDIATELY.
*STRUCTURAL- FLOOR/SUPPORT WALL LOADS- STRUCTURAL ENGINEER TO ASSURE THAT BUILDING AND SHAFT WILL SAFELY SUPPORT ALL LOADS IMPOSED BY THE LIFT EQUIPMENT. REFER TO THE TABLES ON THIS DRAWING FOR LOADS IMPOSED BY THE EQUIPMENT.
WHERE DOORS ARE REQUIRED- SUITABLE LINTELS MUST BE PROVIDED BY OWNER/AGENT. DOOR FRAMES ARE NOT DESIGNED TO SUPPORT OVERHEAD WALL LOADS.
*MACHINE ROOM- LOCATION / ACCESS- MACHINE ROOM LOCATED AT THE LOWEST LEVEL ADJACENT TO HOISTWAY, UNLESS SHOWN OTHERWISE ON THE LAYOUT DRAWINGS. FIELD ADJUSTMENT BY INSTALLER MAY BE NECESSARY TO MEET JOB SITE CONDITIONS OR REGULATIONS. ACCESS TO MACHINE ROOM TO BE THROUGH A SELF CLOSING LOCKING DOOR. SLEEVES FOR OIL & ELECTRIC LINES- FROM MACHINE ROOM TO RUNWAY AS REQUIRED. (POSITION PER INSTALLERS INSTRUCTIONS).

CAB LIGHTS	INPUT VOLTAGE (V/PH/CYCLE)	DISCONNECT SIZE (AMPS)	TIME DELAY FUSE (AMPS)	FULL LOAD CURRENT (AMPS)
MOTOR INF0	208/3PH/60HTZ	30	20	10.6
	230/1PH/60HTZ	60	30	17.0
	115/1PH		15	

*ELECTRICAL- POWER SUPPLY- (SEE SPECIFICATIONS) LOCKABLE FUSED DISCONNECT WITH AUXILIARY CONTACT TO BRAKE THE BATTERY FEED, OR CIRCUIT BREAKERS WITH A 3-POLE BREAKER FOR BATTERY FEED REQUIRED, IN COMPLIANCE WITH ELECTRICAL CODE, AS FOLLOWS:
LOCATED ON WALL ON LOCK JAMB SIDE OF MACHINE ROOM DOOR) PERMANENT POWER- BEFORE INSTALLATION CAN BEGIN, PERMANENT POWER MUST BE SUPPLIED.
LIGHTING- OWNER/AGENT TO ENSURE AT LEAST 5 FTC OR 54 LUX AMBIENT LIGHTING OVER LIFT AREA.
*ENTRANCES- FASCIA PANEL BELOW UPPER LEVEL ENTRANCE- WHERE REQUIRED, FASCIA PANEL MUST BE FASTENED TO A SOLID WALL AND BE PERPENDICULAR TO THE FLOOR AND WALLS. HOISTWAY FASCIA IS NOT SELF-SUPPORTING FOR LONG, CONTINUOUS RUNS VOID OF ENTRANCES. ADEQUATE SUPPORT FOR THE ENTRANCE ASSEMBLY- ENTRANCE ASSEMBLIES MUST BE ADJUSTED TO ALIGN WITH PLATFORM AND INTERLOCK EQUIPMENT. OTHERS TO ALLOW AN ADEQUATE ROUGH OPENING.
RETURN WALLS- RETURN WALLS AT ENTRANCES MUST BE BUILT-IN BY OTHERS AFTER ENTRANCE ASSEMBLIES ARE IN PLACE. ENTRANCE ASSEMBLY MUST BE SECURELY FASTENED TO WALLS BY ELEVATOR CONTRACTOR.

NOTE B

ALL INFORMATION IS SUBJECT TO CHANGE. PLEASE REFERENCE OUR ON-LINE DRAWINGS AT WWW.CONCORDLEVATOR.COM FOR THE MOST RECENT UPDATES

CUSTOMER: _____ DATE: _____
PROJECT: _____ REVISION DATE: _____
LOCATION: _____ COMPLETED BY: _____
JOB No. _____ SHEET No. _____